

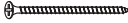

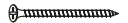

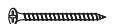
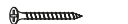
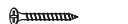
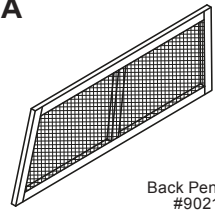
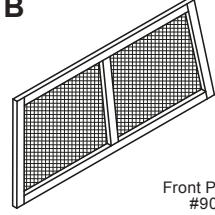
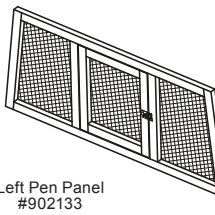
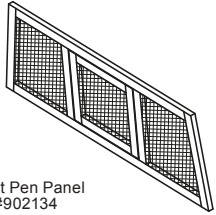
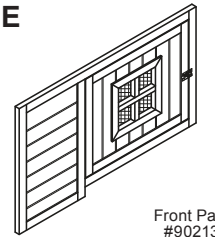
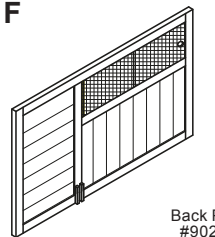
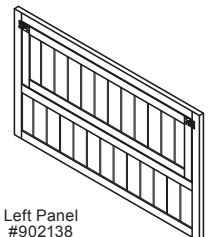
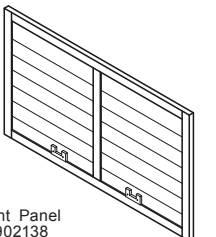
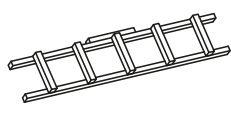
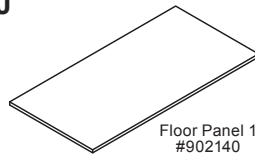
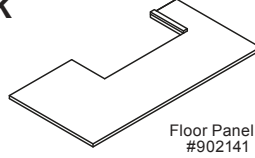
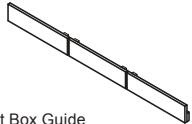

Item #14054

#30014054

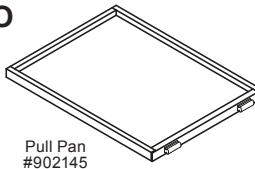
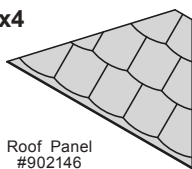
<p>Hardware #902150</p> <p>①  $\varnothing 3.5 \times 60$ 4Pcs</p> <p>②  $\varnothing 3.5 \times 50$ 4Pcs</p> <p>③  $\varnothing 3.5 \times 40$ 23Pcs</p> <p>④  $\varnothing 3.5 \times 30$ 16Pcs</p> <p>⑤  $\varnothing 3.5 \times 25$ 16Pcs</p>	<p>A</p>  <p>Back Pen Panel #902131</p>	<p>B</p>  <p>Front Pen Panel #902132</p>	<p>C</p>  <p>Left Pen Panel #902133</p>	<p>D</p>  <p>Right Pen Panel #902134</p>
	<p>E</p>  <p>Front Panel #902135</p>	<p>F</p>  <p>Back Panel #902136</p>	<p>G</p>  <p>Left Panel #902138</p>	<p>H</p>  <p>Right Panel #902138</p>
	<p>I</p>  <p>Ladder #902139</p>	<p>J</p>  <p>Floor Panel 1 #902140</p>	<p>K</p>  <p>Floor Panel 2 #902141</p>	<p>L</p>  <p>Nest Box Guide #902142</p>
	<p>M x2</p>  <p>Nest Box Divider #902143</p>	<p>N x2</p>  <p>Roost Bar #902144</p>	<p>O</p>  <p>Pull Pan #902145</p>	<p>P x4</p>  <p>Roof Panel #902146</p>
	<p>Q x4</p>  <p>Roof ridge cap #902147</p>	<p>R</p>  <p>Roof Finial #902148</p>	<p>S x4</p>  <p>Handles #902149</p>	

Step 1

Assemble the hutch pen by attaching the Back Wire Panel (A), Front Wire Panel (B), Left Wire Panel (C), and Right Wire Panel (D) using eight $\varnothing 3.5 \times 40$ screws (3).

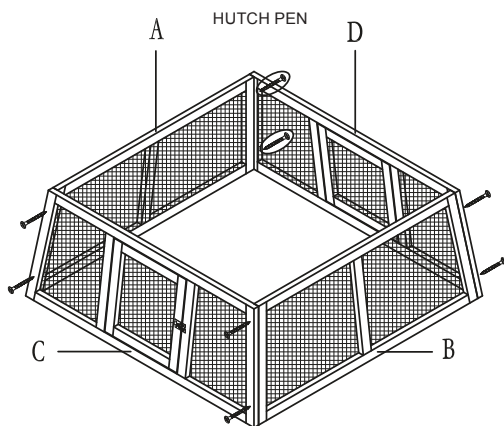

③  $\varnothing 3.5 \times 40$ 8Pcs

Step 2

Assemble the floor by placing Floor Panel 1 (J) and Floor Panel 2 (K) onto the assembled wire base.

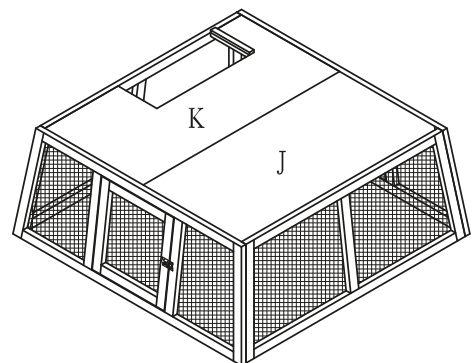

Step 3

Attach the Ladder (I) to Floor Panel 2 (K) using three Ø3.5 x 40 screws.

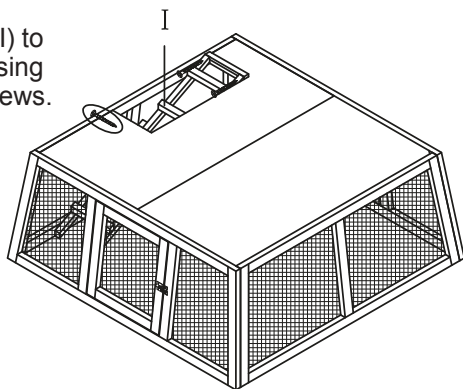

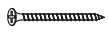
③  Ø3.5x40 3Pcs

Step 4

Assemble the main hutch body by attaching the Front Panel (E), Back Panel (F), Left Panel (G), and Right Panel (H) using eight Ø3.5 x 40 screws (3).

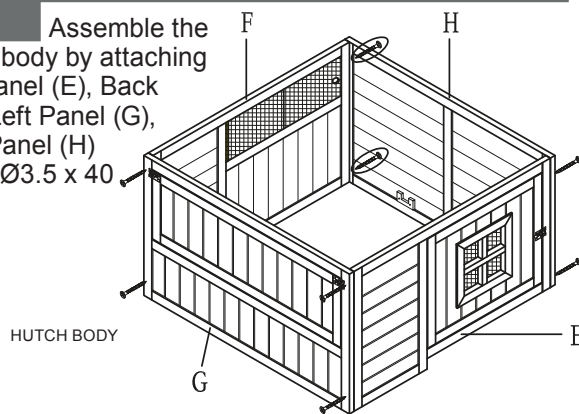

③  Ø3.5x40 8Pcs

Step 5

Assemble the hutch roof by attaching the roof panels (P) to the Roof Ridge Caps (Q) using sixteen Ø3.5 x 30 screws (4).

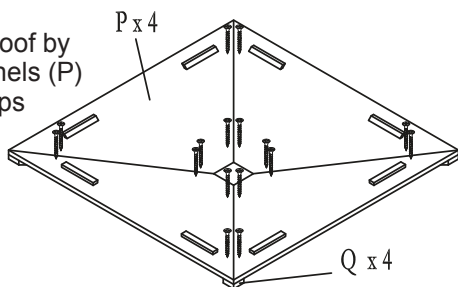

④  Ø3.5x30 16Pcs

Step 6

Attach the Roof Finial (R) to the assembled hutch roof using four 3.5 x 50 screws (2).

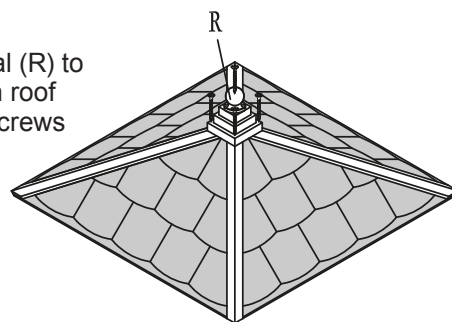

②  Ø3.5x50 4Pcs

Step 7

Attach the Hutch Pen to the Hutch Body using four Ø3.5 x 60 screws (1).

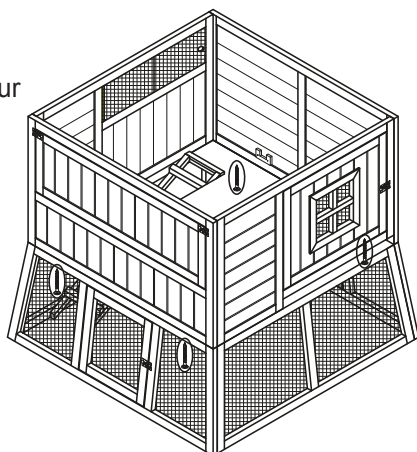

①  Ø3.5x60 4Pcs

Step 8

Place the Nest Box Guide (L) into the wooden slots on the Front and Back Panels of the hutch body.

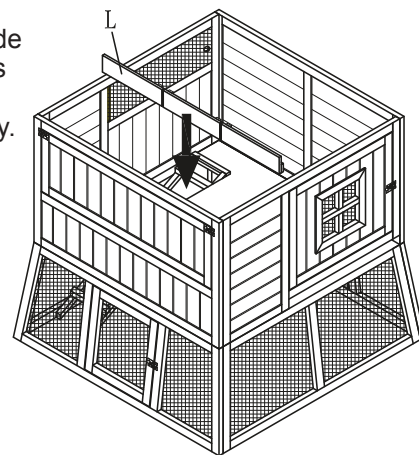

Step 9

Place the Roost Bars (N) into the wooden slots on the Left Panel and Right Panel of the hutch.

Place the Nest Box Dividers (M) into the guide slots in the nest box.

Slide the Pull Pan (O) into the slot on the Front Panel.

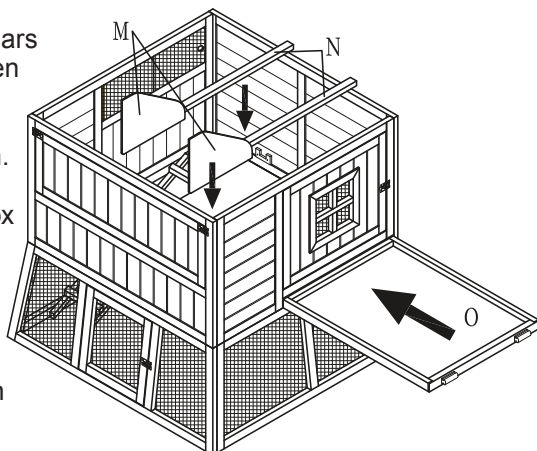

Step 10

Attach the Roof to the Hutch Main Body using four Ø3.5 x 40 screws (3).

Attach the Handles (S) to the hutch pen using sixteen Ø3.5 x 25 screws (5).

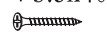
③  Ø3.5x40 4Pcs
⑤  Ø3.5x25 16Pcs

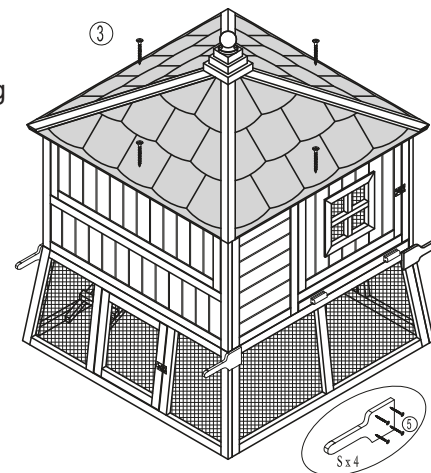

Care Tip

To protect the wood on your hutch you need to re-apply the protective stain finish at least 1x each year. Use a safe and non-toxic water based stain (available at your local paint or hardware center). Keep hutch in a safe area away from high winds and extreme temperatures.

If you have any questions or concerns about this product contact our customer service department at 1-800-295-2243 Mon-Fri 8:00 – 4:00 MST or email us at cs@waremfinc.com